

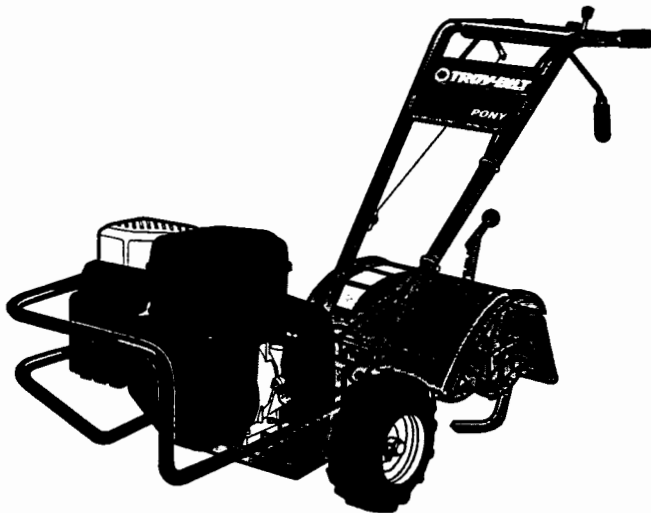

# Operator's Manual

Rear-tine Tiller Model  
664D—Pony®



## **IMPORTANT: READ SAFETY RULES AND INSTRUCTIONS CAREFULLY**

**Warning:** This unit is equipped with an internal combustion engine and should not be used on or near any unimproved forest-covered, brush-covered or grass-covered land unless the engine's exhaust system is equipped with a spark arrester meeting applicable local or state laws (if any). If a spark arrester is used, it should be maintained in effective working order by the operator. In the State of California the above is required by law (Section 4442 of the California Public Resources Code). Other states may have similar laws. Federal laws apply on federal lands. A spark arrester for the muffler is available by contacting the service department at Troy-Bilt LLC, P.O. Box 361131 Cleveland, Ohio 44136-0019.

**TROY-BILT LLC, P.O. BOX 361131, CLEVELAND, OH 44136-0019**

PRINTED IN USA

FROM NO. 770-10597  
(12/2001)

**TABLE OF CONTENTS**

Content	Page
Calling Customer Support .....	2
Safety .....	3
Assembly .....	6
Features and Controls .....	11
Operation .....	14
Maintenance .....	20
Tiller Attachments .....	28
Troubleshooting .....	29
Parts List .....	30
Warranty Information .....	Back Cover

**FINDING MODEL NUMBER**

This Operator's Manual is an important part of your new Rear-tine Tiller. It will help you assemble, prepare and maintain the unit for best performance. Please read and understand what it says.

Before you start assembling your new equipment, please locate the model plate on the equipment and copy the information from it in the space provided below. This information is very important if you need help from our Customer Support Department or an authorized dealer.

- You can locate the model number by looking at the rear surface of the tine shield. A sample model plate is explained below. For future reference, please copy the model number and the serial number of the equipment in the space below

 <p><b>TROY-BILT</b> LLC P. O. BOX 361131 CLEVELAND, OH 44136 330-558-7220 866-840-6483</p>	<p><b>Copy Model Number Here</b> _____</p> <p><b>Copy Serial Number Here</b> _____</p>
--	---

**ENGINE INFORMATION**

The engine manufacturer is responsible for all engine-related issues with regards to performance, power-rating, specifications, warranty and service. Please refer to the engine manufacturer's Owner's/Operator's Manual packed separately with your unit for more information.

**CALLING CUSTOMER SUPPORT**

If you have difficulty assembling this product or have any questions regarding the controls, operation or maintenance of this unit, please call the Customer Support Department.



Call 1- (330) 558-7220 or 1- (866) 840-6483 to reach a Customer Support representative. Please have your unit's model number and serial number ready when you call. See previous section to locate this information. You will be asked to enter the serial number in order to process your call .



Section  
**1**

# Safety

This machine meets voluntary safety standard B71.8 – 1996, which is sponsored by the Outdoor Power Equipment Institute, Inc., and is published by the American National Standards Institute.

### Safety Alert Symbol



This is a safety alert symbol. It is used in this manual and on the unit to alert you to potential hazards. When you see this symbol, read and obey the message that follows it. Failure to obey safety messages could result in personal injury or property damage.

## **WARNING**

**The engine exhaust from this product contains chemicals known to the State of California to cause cancer, birth defects or other reproductive harm.**

### TRAINING

1. Carefully read this Owner's Manual, the separate Engine Owner's Manual, and any other literature you may receive. Be thoroughly familiar with the controls and the proper use of the tiller and its engine. Know how to stop the unit and disengage the controls quickly.
2. Never allow children to operate the tiller. Never allow adults to operate the tiller without proper instruction.
3. Keep the area of operation clear of all persons, particularly children and pets.
4. Keep in mind that the operator or user is responsible for accidents or hazards occurring to other people, their property and themselves.



5. Do not till near underground electric cables, telephone lines, pipes or hoses. If in doubt, contact your telephone or utility company.

6. **Warning: Handle fuel with care; it is highly flammable and its vapors are explosive. Take the following precautions:**
  - a. Store fuel in containers specifically designed for this purpose.
  - b. The gas cap shall never be removed or fuel added while the engine is running. Allow the engine to cool for several minutes before adding fuel.
  - c. Keep matches, cigarettes, cigars, pipes, open flames, and sparks away from the fuel tank and fuel container.
  - d. Fill fuel tank outdoors with extreme care. Never fill fuel tank indoors. Use a funnel or spout to prevent spillage.
  - e. Replace all fuel tank and container caps securely.
  - f. If fuel is spilled, do not attempt to start the engine, but move the machine away from the area of spillage and avoid creating any source of ignition until fuel vapors have dissipated.

7. Never make adjustments when engine is running (unless recommended by manufacturer).

### OPERATION

1. Do not put hands or feet near or under rotating parts.
2. Exercise extreme caution when on or crossing gravel drives, walks, or roads. Stay alert for hidden hazards or traffic. Do not carry passengers.
3. After striking a foreign object, stop the engine (and remove the ignition key on electric start models), disconnect the spark plug wire and prevent it from touching the spark plug, carefully inspect the tiller for any damage, and repair the damage before restarting and operating the tiller.
4. Exercise caution to avoid slipping or falling.
5. If the unit should start to vibrate abnormally, stop the engine (and remove the ignition key on electric start models). Disconnect the spark plug wire and prevent it from touching the spark plug, and check immediately for the cause. Vibration is generally a warning of trouble.
6. Stop the engine (and remove the ignition key on electric start models), disconnect the spark plug wire and prevent it from touching the spark plug whenever you leave the operating position, before unclogging the tines, or when making any repairs, adjustments or inspections.

### PREPARATION

1. Thoroughly inspect the area where the tiller is to be used and remove all foreign objects.
2. Be sure all controls are released and the Wheel Gear Lever is in ENGAGE before starting the engine.
3. Do not operate the tiller without wearing adequate outer garments. Avoid loose garments or jewelry that could get caught in moving parts.
4. Do not operate the tiller when barefoot or wearing sandals, sneakers, or light footwear. Wear protective footwear that will improve footing on slippery surfaces.

7. Take all possible precautions when leaving the machine unattended. Stop the engine. Remove ignition key on electric start models. Disconnect spark plug wire and move it away from the spark plug. Move Wheel Gear Lever to ENGAGE.

8. Before cleaning, repairing, or inspecting, stop the engine, remove the ignition key on electric start models, and make certain all moving parts have stopped. Disconnect the spark plug wire and prevent it from touching the spark plug to prevent accidental starting. On electric start models, always remove the cable from the negative side (-) of the battery.

9. Always keep the tiller tine hood flap down, unless using the tiller/furrower attachment.

10. Never use the tiller unless proper guards, plates, or other safety protective devices are in place.

11. Do not run engine in an enclosed area. Engine exhaust contains carbon monoxide gas, a deadly poison that is odorless, colorless, and tasteless.

12. Keep children and pets away.

13. **Never operate the tiller under engine power if the Wheel Gear Lever is in DISENGAGE (FREEWHEEL). In this position, the wheels will not hold the tiller back and the revolving tines could propel the tiller rapidly, possibly causing loss of control.** Always move the Wheel Gear Lever to ENGAGE before starting the engine or engaging the tines/wheels with the Forward Clutch Control or the Reverse Clutch Control.

14. **Be aware that the tiller may unexpectedly bounce upward or jump forward if the tines should strike extremely hard packed soil, frozen ground, or buried obstacles like large stones, roots, or stumps. If in doubt about the tilling conditions, always use the following operating precautions to assist you in maintaining control of the tiller:**

- a. **Walk behind and to one side of the tiller, using one hand on the handlebars. Relax your arm, but use a secure hand grip.**

- b. **Use shallower depth regulator settings, working gradually deeper with each pass.**

- c. **Use slower engine speeds.**

- d. **Clear the tilling area of all large stones, roots and other debris.**

- e. **Avoid using downward pressure on handlebars. If need be, use slight upward pressure to keep the tines from digging too deeply.**

- f. **Before contacting hard packed soil at the end of a row, reduce engine speed and lift handlebars to raise tines out of the soil.**

- g. **In an emergency, stop tines and wheels by releasing whichever Clutch Lever is engaged. Do not attempt to restrain the tiller.**

15. Do not overload the tiller's capacity by attempting to till too deeply at too fast a rate.

16. Never operate the tiller at high transport speeds on hard or slippery surfaces. Look behind and use care when backing up.

17. Do not operate the tiller on a slope that is too steep for safety. When on slopes, slow down and make sure you have good footing. Never permit the tiller to freewheel down slopes.

18. Never allow bystanders near the unit.

19. Only use attachments and accessories that are approved by the tiller manufacturer.

20. Use tiller attachments and accessories when recommended.

21. Never operate the tiller without good visibility or light.

22. Never operate the tiller if you are tired, or under the influence of alcohol, drugs or medication.

23. Operators shall not tamper with the engine-governor settings on the machine; the governor controls the maximum safe operating speed to protect the engine and all moving parts from damage caused by overspeed. Authorized service shall be sought if a problem exists.

24. Do not touch engine parts which may be hot from operation. Let parts cool down sufficiently.

25. The battery on electric start model tillers contains sulfuric acid. Avoid contact with skin, eyes, or clothing. Keep out of the reach of children.

**Antidote—External Contact:** Flush immediately with lots of water.

**Antidote—Internal:** Drink large quantities of water or milk. Follow with milk of magnesia, beaten eggs or vegetable oil. Call a doctor immediately.

**Antidote—Eye Contact:** Flush with water for 15 minutes. **Get prompt medical attention.**

26. Batteries produce explosive gases. Keep sparks, flame, and smoking materials away. Ventilate when charging batteries or when using a battery in an enclosed space. ALWAYS wear safety goggles when working near batteries.

27. Please remember: You can always stop the tines and wheels by releasing the Forward Clutch Control Lever or the Reverse Clutch Control knob (whichever control you have engaged), or by moving the Engine Throttle Control Lever (located on engine) to STOP on recoil start models or by turning the ignition key to OFF on electric start models.

28. To load or unload the tiller, see the instructions in Section 4 of this Manual.

29. Use extreme caution when reversing or pulling the machine towards you.

30. Start the engine carefully according to instructions and with feet well away from the tines.

31. Never pick up or carry a machine while the engine is running.

## MAINTENANCE AND STORAGE

1. Keep the tiller, attachments and accessories in safe working condition.

2. Check all nuts, bolts, and screws at frequent intervals for proper tightness to be sure the equipment is in safe working condition.

3. Never store the tiller with fuel in the fuel tank inside a building where ignition sources are present such as hot water and space heaters, furnaces, clothes dryers, stoves, electric motors, etc. Allow engine to cool before storing in any enclosure.

4. To reduce the chances of a fire hazard, keep the engine free of grass, leaves, or excessive grease.
5. Store gasoline in a cool, well-ventilated area, safely away from any spark- or flame-producing equipment. Store gasoline in an approved container, safely away from the reach of children.
6. Refer to the Maintenance section of this Manual and in the separate Engine Owner's Manual for instructions if the tiller is to be stored for an extended period.
7. Never perform maintenance while the engine is running or the spark plug wire is connected, except when specifically instructed to do so.
8. If the fuel tank has to be drained, do this outdoors.

## DECALS

For your safety and the safety of others, various safety message decals are on your unit (see Figure below). Keep the decals clean and legible at all times. Contact your local service dealer or the factory for

replacements if any decals are damaged or missing.

Refer to the Parts List pages for decal locations and part numbers.

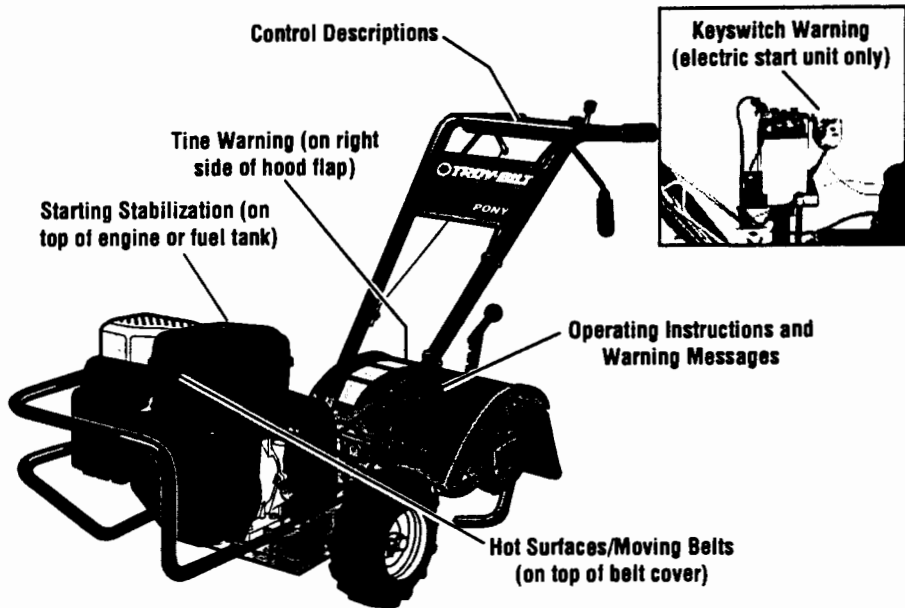

Figure 1: Location of Safety and Operating Decals

### Operating Symbols

Various symbols (shown here, with word descriptions) may be used on the tiller and engine.



### WARNING

#### TO AVOID SERIOUS INJURY:

- READ THE OWNER'S MANUAL.
- KNOW LOCATIONS AND FUNCTIONS OF ALL CONTROLS.
- KEEP ALL SAFETY DEVICES AND SHIELDS IN PLACE AND WORKING.
- NEVER ALLOW CHILDREN OR UNINSTRUCTED ADULTS TO OPERATE TILLER.
- SHUT OFF ENGINE AND DISCONNECT SPARK PLUG WIRE BEFORE MANUALLY UNCLOGGING TINES OR MAKING REPAIRS.
- KEEP BYSTANDERS AWAY FROM MACHINE.
- KEEP AWAY FROM ROTATING PARTS.
- USE EXTREME CAUTION WHEN REVERSING OR PULLING THE MACHINE TOWARDS YOU.

**WARNING**

To prevent personal injury or property damage, do not start the engine until all assembly steps are complete and you have read and understand the safety and operating instructions in this Manual.

**INTRODUCTION**

Carefully follow these assembly steps to correctly prepare your tiller for use. It is recommended that you read this Section in its entirety before beginning assembly.

**INSPECT UNIT**

Inspect the unit and carton for damage immediately after delivery. Contact the carrier (trucking company) if you find or suspect damage. Inform them of the damage and request instructions for filing a claim. To protect your rights, put your claim in writing and mail a copy to the carrier within 15 days after the unit has been delivered. Contact us at the factory if you need assistance in this matter.

**UNPACKING AND ASSEMBLY INSTRUCTIONS****STEP 1: UNPACKING INSTRUCTIONS**

1. Remove any cardboard inserts and packaging material from the carton. Remove any staples from the bottom of the carton and remove the carton.
2. Cut the large, plastic tie strap that secures the transmission tube to the shipping pallet. Leave the handlebars on top of the tiller to avoid damaging any cables.
3. A bag with loose hardware is inside the literature envelope. Check the contents against the following list and Figure 2-1. Contact your local dealer or the factory if any items are missing or damaged.

NOTE: For electric start units, a second hardware bag is located near the battery.

4. The tiller is heavy. You should not attempt to remove it from the shipping platform until instructed to do so in these "Assembly" steps.

**HARDWARE BAG PARTS LIST**

Fig. Ref.	Qty.	Description
1	2	3/8"-16 x 1" Hex Hd. Screw
2	1	Keyed Washer
3	1	Wheel Gear Lever Knob
4	1	Height Adjustment Flange Screw (See Figure 2-1A)
5	2	3/8" Flat Washer
6	2	#10 Lockwasher
7	2	3/8"-16 Nylock Lock Nut
8	2	#10-32 x 1/2" Round Hd. Screw
9	2	#10-32 Nut
10	1	Cotter Pin (not used)
11	4	Plastic Tie Strap (2 not used)

**Tools/Materials Needed for Assembly**

- (1) 3/8" open-end wrench\*
  - (1) 7/16" open-end wrench\* (electric start unit only)
  - (2) 9/16" open-end wrench\*
  - (1) 7/8" open-end wrench or 8" long adjustable wrench
  - (1) Scissors (to trim plastic ties)
  - (1) Ruler
  - (1) Small board (to tap plastic knob on lever)
  - (1) Tire pressure gauge
  - (1) Clean oil funnel
  - (1) Clean, high-quality motor oil. Refer to the separate Engine Owner's Manual for motor oil specifications and quantity required.
- \* Adjustable wrenches may be used.

**IMPORTANT:** Motor oil must be added to the engine crankcase before the engine is started. Follow the instructions in this "Assembly" Section and in the separate Engine Owner's Manual.

NOTE: LEFT and RIGHT sides of the tiller are as viewed from the operator's position behind the handlebars.

**STEP 2: ATTACH HANDLEBARS**

1. On electric start units, remove one screw and lockwasher from the curved

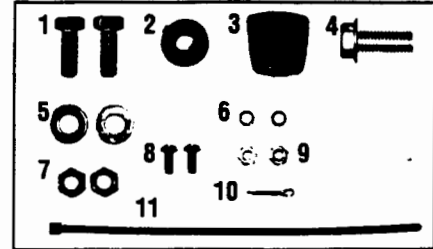

Figure 2-1: Loose hardware (shown in reduced size).

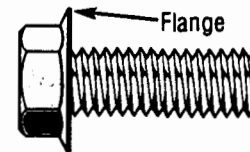

Figure 2-1A Handlebar height adjustment uses the flange head screw.

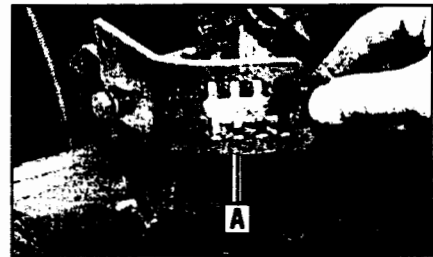

Figure 2-2: On electric start units, move height adjustment bracket (A, Figure 2-2), loosen the second screw, and swing the bracket to one side.

height adjustment bracket (A, Figure 2-2), loosen the second screw, and swing the bracket to one side.

2. Cut the large, plastic cable ties that secure the handlebar ends to the handlebar mounting tabs on the transmission top cover.

3. Gently lift handlebar (do not overstretch attached cable) and place handlebar cross-brace (B, Figure 2-3) in front of curved height adjustment bracket (C).

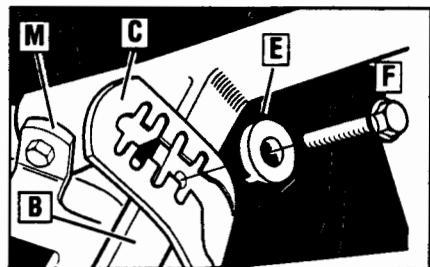

Figure 2-3: Forward clutch control cable not shown for clarity.

4. With the forward clutch cable (N, Figure 2-4) on the inside of handlebar, position the handlebar ends on the outside of the two mounting tabs (M, Figure 2-3) on the transmission top cover.

NOTE: The curved handlebar height adjustment bracket appears as shown in C, Figure 2-3 for non-electric start units. For electric start units, the bracket is loosened and moved to one side.

5. Loosely attach the handlebars to the mounting tabs with two 3/8-16 x 1" screws (heads of screws go to inside of tabs), 3/8" flat washers and 3/8"-16 lock nuts (O, Figure 2-4).

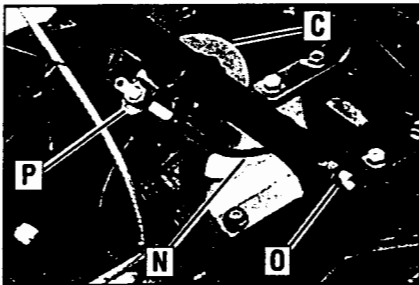

Figure 2-4: Attach handlebars.

6. On electric start units, reattach the height adjustment bracket (A, Figure 2-2). Tighten both screws securely. Make sure the handlebar cross-brace (B, Figure 2-3) is under the bracket.

7. Move the handlebars up or down to align the threaded hole in the cross-brace with one of the four slots in the curved height adjustment bracket. Place the keyed washer (E, Figure 2-3) on the flange head height adjustment screw (F) with the raised keys (edges) of the washer facing down.

8. Thread the height adjustment screw (F, Figure 2-3) into the hole in the handlebar cross-brace, making sure that the raised keys on the washer fit into the slot on the height adjustment bracket. Tighten the height adjustment screw securely. Next, securely tighten the two screws and nuts in the ends of the handlebar (M, Figure 2-3).

9. To remove the tiller from its shipping platform, first carefully unwrap the wheel gear cable (with attached lever - see Figure 2-5) from around the chassis. Move the Wheel Gear Lever (G) to the DISENGAGE position--this allows the wheels to rotate freely. Use the handle-

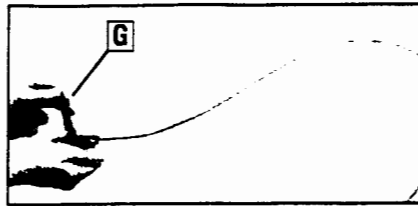

Figure 2-5: Carefully unwrap Wheel Gear Lever and move lever to DISENGAGE.

bars to roll the tiller off the platform.

NOTE: The Wheel Gear Lever will be installed later in this procedure.

**IMPORTANT:** Use the DISENGAGE position only when the engine is not running. Before starting the engine, the Wheel Gear Lever must be placed in the ENGAGE position (see Section 3 for details).

### STEP 3: ATTACH REVERSE CLUTCH CONTROL CABLE

1. Carefully unwrap the reverse clutch control cable (H, Figure 2-6) from its shipping position and route it up along the inside edge of the left side handlebar. A knob and large hex nut (I) is installed on the cable.

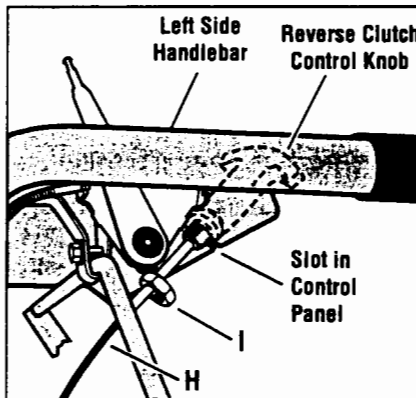

Figure 2-6: Attach reverse clutch control assembly to slotted hole in handlebar panel.

2. Insert the cable into the slot in the control panel and fit the threaded assembly into the hole in the slot (see Figure 2-6). Be sure that the flat side of the threaded assembly is aligned with the flat side of the hole. Slide the hex nut (I) up the cable and tighten it securely.

3. Test the function of the reverse clutch control cable by pulling the knob out and releasing it. The knob should return to its neutral position against the tapered bushing. If it doesn't, contact your local dealer or the factory for technical assistance.

### STEP 4: ATTACH FORWARD CLUTCH CONTROL CABLE

1. Remove any fasteners (rubber bands, tape, etc.) that may secure the Forward Clutch Control levers (J, Figure 2-7) to the handlebar.

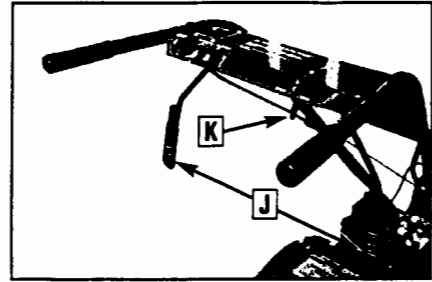

Figure 2-7: Forward Clutch Control levers (J). Forward clutch control linkage (K).

2. The forward clutch control cable (with attached spring) is hanging loosely near the right-side wheel. Being careful not to kink or stretch the cable, insert the z-connector (L, Figure 2-8 - end of the spring) into the hole at the end of the forward clutch control linkage (K, Figure 2-7).

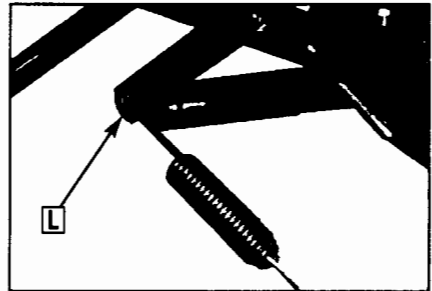

Figure 2-8

3. Attach the cable adjuster (A, Figure 2-9) to the bracket on the right-side handlebar. Use two 1/2" wrenches to loosen the two jam nuts (B) just enough to slide the cable adjuster onto the bracket. Then hand tighten the jam nuts.

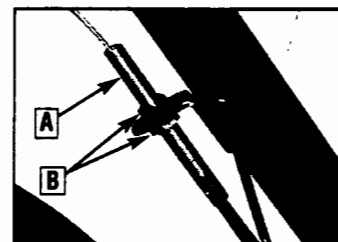

Figure 2-9

**CAUTION**

Incorrect cable adjustment could cause the wheels and tines to rotate unexpectedly. Follow adjustment procedures carefully. Failure to do so could result in personal injury or property damage.

4. Check for correct spring/cable tension as instructed in Section 5, *Checking and Adjusting Forward Clutch Belt Tension*.
5. When tension is correct, tighten the two jam nuts (B) securely.

**STEP 5: CHECK TRANSMISSION GEAR OIL LEVEL**

The transmission was filled with gear oil at the factory. However, be sure to check the oil level at this time to make certain it is correct.

**IMPORTANT:** Do not operate the tiller if the gear oil level is low. Doing so will result in severe damage to the transmission components.

1. With the tiller on level ground, pull the Depth Regulator Lever (R, Figure 2-13) back and then slide it to the second notch from the top. **NOTE:** If the lever does not move, lift the tine hood flap and look for a plastic tie securing the lever in place. Cut and remove the tie.
2. Remove the oil level check plug (M, Figure 2-10) on the left-side of the transmission. (Due to dried paint on the plug threads, it may require some force to remove the plug the first time.) The gear oil level is correct if oil starts to flow out of the hole as the plug is removed. If so, securely reinstall the plug.

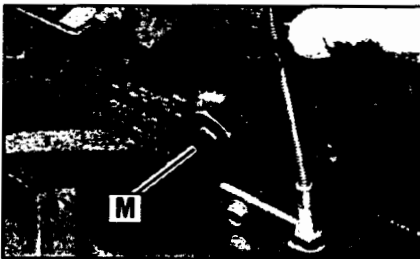

Figure 2-10: Gear oil level check plug.

3. If oil does not flow from the check hole, add oil as follows:

**NOTE:** Do not use automatic transmission fluid or motor oil in the transmission.

- (a) Clean area around the fill hole (N, Figure 2-11) and unscrew gear oil fill plug.

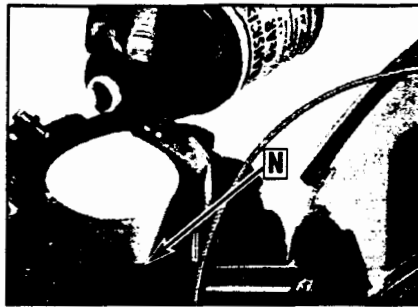

Figure 2-11: Adding gear oil.

- (b) If adding only a few ounces of gear oil, use API rated GL-4 or GL-5 gear oil having a viscosity of SAE 140, SAE 85W-140 or SAE 80W-90. If refilling an empty transmission, use only GL-4 gear oil having a viscosity of SAE 85W-140 or SAE 140.

- (c) Using a clean funnel, slowly add gear oil until it flows from the gear oil level check hole (N, Figure 2-11).

- (d) Reinstall and tighten securely the gear oil fill plug (M, Figure 2-10).

**STEP 6: ADD MOTOR OIL TO ENGINE**

The tiller is shipped *without* oil in the engine crankcase.

**IMPORTANT:** Do not start the engine without first adding motor oil. Severe engine damage will result if the engine is run without oil.

1. Refer to the separate Engine Owner's Manual for motor oil specifications and capacities.
2. With the unit on level ground, move the Depth Regulator Lever (R, Figure 2-13) up or down until the engine is level.
3. Add motor oil as described in the Engine Owner's Manual.
4. Move the Depth Regulator Lever all the way down until the highest notch is engaged. This places the tines in the "travel" position.

**STEP 7: ATTACH WHEEL GEAR LEVER**

1. Insert the Wheel Gear Lever (P, Figure 2-12) up through the slot in the control panel that is labeled "WHEEL GEAR."
2. Insert two #10-32 x 1/2" round head screws down through the "+" marks on the control panel decal and securely attach the wheel gear mounting bracket using two #10 lockwashers and #10-32 nuts.

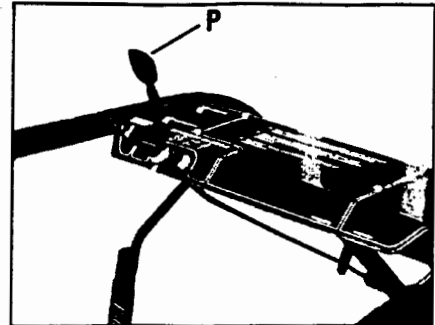

Figure 2-12: Attach Wheel Gear Lever.

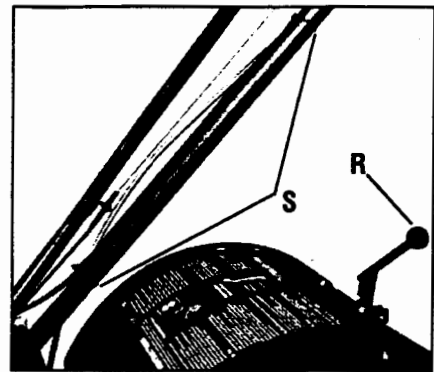

Figure 2-13: Attach wheel gear cable and reverse clutch cable with cable ties (S).

3. Use a small board to tap the Wheel Gear Lever knob securely onto the lever.
4. Secure the wheel gear cable and the reverse clutch control cable to the left-side handlebar with two plastic ties (S, Figure 2-13) located about two feet apart. Snip off any excess tie length with scissors.

**STEP 8: CHECK AIR PRESSURE IN TIRES**

Use a tire pressure gauge to check the air pressure in both tires. Deflate or inflate both tires equally to 15-to-20 PSI (pounds per square inch). Be sure that both tires are inflated equally or the unit will pull to one side.

**STEP 9: CHECK HARDWARE FOR TIGHTNESS**

Inspect the hardware on the unit and tighten any loose screws, bolts and nuts.

**IMPORTANT:**

- This completes assembly for recoil start tillers. Read the rest of this Manual, and the separate Engine Owner's Manual, before operating the tiller.
- Electric start models--continue with the Assembly Steps.





### ⚠ WARNING

Before operating your machine, carefully read and understand all safety, controls and operating instructions in this Manual, the separate Engine Owner's Manual, and on the decals on the machine.

Failure to follow these instructions can result in serious personal injury.

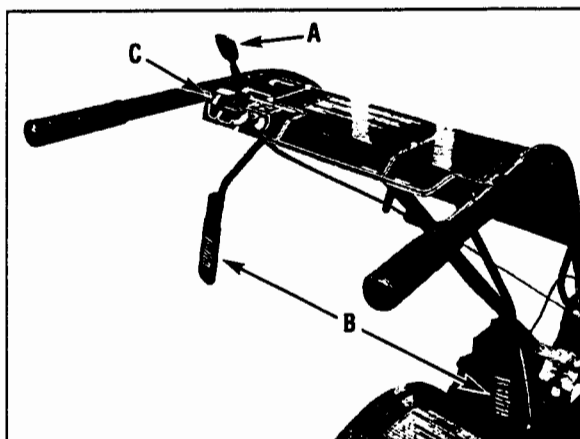

Figure 3-1: Controls located on handlebar.

## INTRODUCTION

This Section describes the location and function of the controls on your tiller. Refer to the following section "Operation" for detailed operating instructions.

Practice using these controls, with the engine shut off, until you understand the operation of the controls and feel confident with them.

**IMPORTANT:** Refer to the separate engine manufacturer's Engine Owner's Manual for information about the controls on the engine.

### WHEEL GEAR LEVER

This lever (A, Figure 3-1) has two positions: ENGAGE and DISENGAGE.

In the ENGAGE position, the wheels will start turning when either the Forward Clutch Control or the Reverse Clutch Control is engaged (the tines will also start turning when either clutch is engaged).

The DISENGAGE position places the wheels in the freewheeling mode to allow the unit to be moved without the engine running. Use the DISENGAGE position only when the engine is not running. See "DANGER" statement that follows.

To shift to ENGAGE, gently (do not force) move the lever forward while also rolling the tiller a few inches forward or backward. Moving the tiller helps to align the shift mechanism with the transmission wheel drive gears.

To shift to DISENGAGE (freewheel), move the lever rearward, without rolling the tiller. The wheels will roll freely when the lever is properly set in the DISENGAGE position.

### ⚠ DANGER

Never place the Wheel Gear Lever in DISENGAGE (Freewheel) when the engine is running.

Having the Wheel Gear Lever in DISENGAGE and then engaging the tines/wheels with either the Forward Clutch Control or the Reverse Clutch Control could allow the tines to propel the tiller rapidly forward or backward.

Failure to follow this instruction could result in personal injury or property damage.

### FORWARD CLUTCH CONTROL

The two interconnected levers (B, Figure 3-1) control the engagement of forward drive to the wheels and tines.

#### To Operate the Forward Clutch Control:

1. Before engaging the Forward Clutch Control, put the Wheel Gear Lever in the ENGAGE position (see "WARNING" below).
2. Pull up and hold one or both of the levers against the handlebar grips to engage the wheels and tines.
3. Release BOTH levers to disengage (stop) the wheels and tines. All forward motion will stop (the engine will continue to run).

### ⚠ WARNING

Never engage the wheels and tines with the Forward Clutch Control or the Reverse Clutch Control unless the Wheel Gear Lever is in ENGAGE.

Engaging the Forward Clutch Control or the Reverse Clutch Control when the wheels are not engaged could allow the tines to rapidly propel the tiller forward or backward.

Failure to follow this warning could result in personal injury or property damage.

### REVERSE CLUTCH CONTROL

The Reverse Clutch Control (C, Figure 3-1) controls the engagement of reverse drive to the wheels and tines. **The reversing feature is used for maneuvering the tiller only – never engage the tines in the ground while going in the reverse direction.**

#### ⚠ WARNING

- Use extreme caution when reversing or pulling the machine towards you. Look behind to avoid obstacles.
- Never attempt to till in reverse.

Failure to follow this warning could result in personal injury or property damage.

#### To Operate the Reverse Clutch Control:

1. Put the Wheel Gear Lever in the ENGAGE position (see the "WARNING" statement on previous page).
2. Stop all tiller motion by releasing the Forward Clutch Control levers.
3. Lift up the handlebars until the tines clear the ground, look behind you to avoid any obstacles, and then pull the Reverse Clutch Control knob out. The tines and wheels will rotate in a reverse direction.
4. Release the Reverse Clutch Control knob to disengage (stop) the wheels and tines. All reverse motion will stop (the engine will continue to run).

#### ⚠ WARNING

- Do not attempt to till too deeply too quickly. Gradually work down to deeper tilling depths.
- Place the Depth Regulator Lever in the "travel" position before starting the engine. This position prevents the tines from touching the ground until you are ready to begin tilling.

Failure to follow this warning could result in personal injury or property damage.

### DEPTH REGULATOR

The Depth Regulator lever (D, Figure 3-2) controls the tilling depth of the tines. Pull the lever straight back and slide it up or down to engage the notched height settings.

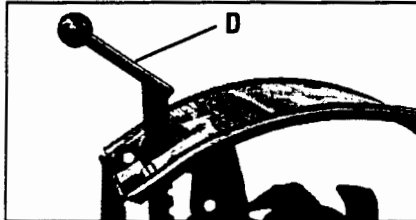

Figure 3-2: Depth Regulator Lever.

The highest notch (lever all the way down) raises the tines approximately 1-1/2 inches off the ground. This "travel" position allows the tiller to be moved without the tines digging into the ground.

Moving the lever up increases the tilling depth. The lowest notch allows a tilling depth of approximately six to eight inches, depending on soil conditions.

**For best results, always begin tilling at a very shallow depth setting and gradually increase the tilling depth.** Complete details on using the Depth Regulator are found in the "Operation" Section of this manual.

### HANDLEBAR HEIGHT ADJUSTMENT

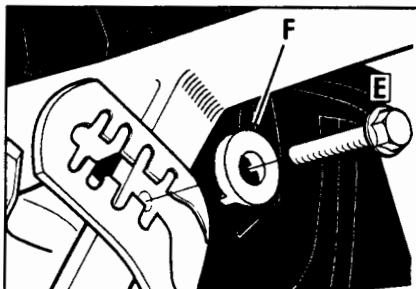

Figure 3-3: Handlebar height adjustment.

The handlebar height is adjustable to four different settings. Set the handlebar height to a comfortable setting, but keep in mind that the handlebars will be lower when the tines are engaged in the soil.

#### To Adjust the Handlebar Height:

1. Stop the engine, wait for all parts to stop moving and then disconnect the spark plug wire. Remove the ignition key on electric start models.

2. Loosen the two screws at the lower ends of the handlebar.

3. Loosen the height adjustment screw (E, Figure 3-3) and pull the keyed washer (F) free of the slots in the curved height adjustment bracket.

4. Move the handlebars to the new slot setting and insert the raised keys on the keyed washer into the slot. Tighten the height adjustment screw securely.

5. Retighten the two screws at the ends of the handlebar.

### ENGINE CONTROLS

Refer to the engine manufacturer's Engine Owner's Manual (included in the tiller literature package) to identify the controls on your engine. The following two controls are used when stopping or starting the engine.

**IMPORTANT:** The control for stopping the recoil start engine is located on the engine.

#### ENGINE THROTTLE CONTROL LEVER

The Engine Throttle Control Lever (located on engine--see Figure 4-1) is used to regulate the engine speed. On the recoil start model only, it is also used to stop the engine (on the electric start model, the electric start keyswitch is used to stop the engine). The throttle settings are shown below.

**IMPORTANT:** See "Starting and Stopping the Engine" in the "Operation" Section for detailed engine starting and stopping instructions.



**FAST** - Use for most tilling and cultivating projects.



**SLOW** - Use when idling engine or when slower tilling and cultivating speeds are needed.



**STOP** - Stops the engine (on recoil start models only).

## ⚠ WARNING

Before operating your machine, carefully read and understand all safety (Section 1), controls (Section 3) and operating instructions (Section 4) in this Manual, in the separate Engine Owner's Manual, and on the decals on the machine.

Failure to follow these instructions can result in serious personal injury.

## INTRODUCTION

Read this Section of the manual thoroughly before you start the engine. Then, take the time to familiarize yourself with the basic operation of the tiller before using it in the garden.

Find an open, level area and practice using the tiller controls without the tines engaging the soil (put tines in "travel" setting). Only after you've become completely familiar with the tiller should you begin using it in the garden.

## BREAK-IN OPERATION

Perform the following maintenance after the first two hours of new operation (see "Maintenance" in this manual and the Engine Owner's Manual).

1. Change engine oil.
2. Check for loose or missing hardware on unit. Tighten or replace as needed.
3. Check transmission gear oil level.
4. Check tension on forward clutch belt.

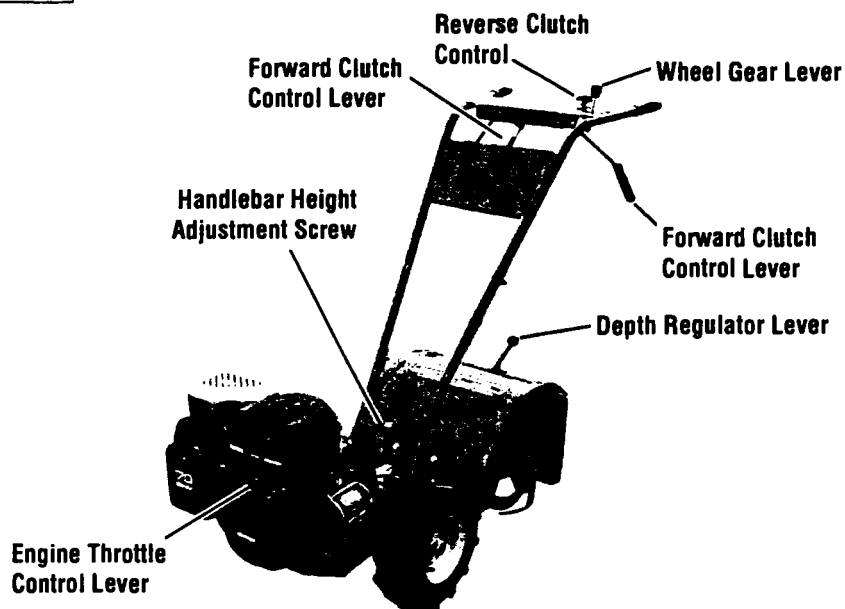

Figure 4-1: Location of main tiller controls.

## STARTING AND STOPPING THE ENGINE

### ⚠ CAUTION

To help prevent serious personal injury or damage to equipment:

- Before starting engine, put Wheel Gear Lever in ENGAGE position.
- Before starting engine, put Forward Clutch Control levers and Reverse Clutch Control in neutral (disengaged) positions by releasing controls.
- Never run engine indoors or in enclosed, poorly ventilated areas. Engine exhaust contains carbon monoxide, an odorless and deadly gas.
- Avoid engine muffler and nearby areas. Temperatures in these areas may exceed 150°F.

## PRE-START CHECKLIST:

Make the following checks and perform the following services before starting the engine.

1. Read Sections 1 and 3 in this Manual. Read the separate Engine Owner's Manual.
2. Check unit for loose or missing hardware. Service as required.
3. Check engine oil level. See Engine Owner's Manual.
4. Check that all safety guards and covers are in place.
5. Check air cleaner and engine cooling system. See Engine Owner's Manual.
6. Attach spark plug wire to spark plug.

### ⚠ DANGER

**GASOLINE IS HIGHLY FLAMMABLE AND ITS VAPORS ARE EXPLOSIVE.**

Follow gasoline safety rules in this manual (see Section 1) and in the separate Engine Owner's Manual.

Failure to follow gasoline safety instructions can result in serious personal injury and property damage.

7. Fill the fuel tank with gasoline according to the directions in the separate Engine Owner's Manual. Follow all instructions and safety rules carefully.

**STARTING THE ENGINE**

The following steps describe how to start and stop the engine. **Do not attempt to engage the tines or wheels until you have read all of the operating instructions in this Section. Also review the safety rules in Section 1: "Safety" and the tiller and engine controls information in Section 3: "Features and Controls."**

1. Complete the "Pre-Start Checklist" on the previous page.
2. Put the Wheel Gear Lever (Figure 4-1) in the ENGAGE position.
3. Put the Depth Regulator Lever in the "travel" position (lever all the way down) so that the tines are clear of the ground.
4. Release all controls on the tiller.
5. Put the Engine Throttle Control Lever (Figure 4-1) in the "FAST" setting.
6. On engines equipped with a fuel valve, turn valve to open position as instructed in the separate engine manual.
7. Choke or prime engine as instructed in the separate Engine Owner's Manual.
8. For recoil (non-electric) starting models:
  - (a) Place one hand on fuel tank to stabilize unit when you pull the starter handle.
  - (b) Use the recoil starter rope to start the engine as instructed in the separate Engine Owner's Manual. When the engine starts, gradually move the choke lever (on engines so equipped) to the "NO CHOKE", "CHOKE OFF" or "RUN" position.
  - (c) Leave the Engine Throttle Control Lever in the "FAST" setting.
9. For electric starting models:
  - (a) Turn the engine ignition key to the "START" setting and allow the starter motor to crank the engine for several seconds. Avoid cranking the engine longer than 15 seconds at a time as doing so could damage the starter motor. **NOTE:** Refer to the Engine Owner's Manual for detailed starting instructions.

- (b) When the engine starts, release the key and it will return to the "RUN" setting.
- (c) Gradually move choke lever (on engines so equipped) to "NO CHOKE", "CHOKE OFF" or "RUN" position.
- (d) Leave the Engine Throttle Control Lever in the "FAST" setting.

**To Start the Electric Start Engine With the Recoil Starter Rope**

If necessary, the electric start engine can be started with the recoil starter rope by following the steps below:

1. If the battery is not "dead" or damaged, leave it connected to the tiller so it will be recharged during engine operation. Make sure the battery cells are filled to the UPPER LEVEL line with electrolyte.
2. If the battery is "dead" or damaged, remove it (refer to "Battery Removal and Installation" in Section 5) and have it tested. Before starting engine, cover the terminal on the loose end of the positive (+) cable with the insulated boot and secure it in place with electrical tape to prevent electrical sparks.
3. Put the ignition key in the "RUN" position and then follow Steps 1-8 of "Starting the Engine."

**STOPPING THE ENGINE**

1. To stop the wheels and tines, release the Forward Clutch Control levers or the Reverse Clutch Control knob (whichever control is engaged).
2. To stop the engine on the recoil start model, move the Engine Throttle Control Lever to the "STOP" position.
3. To stop the engine on an electric start model, move the ignition key to "OFF".

**IMPORTANT:** After stopping an electric start engine, remove the ignition key from the switch to reduce the possibility of unauthorized starting of the engine.

**OPERATING THE TILLER**

The following pages provide guidelines to using your tiller effectively and safely in various gardening applications. Be sure to read "Tilling Tips & Techniques" in this Section before you actually put the tines into the soil.

This is a traditional "standard rotating tine" tiller with forward rotating tines. It operates completely differently from CRT (Counter Rotating Tines) tillers or from low-cost front tine tillers.

1. Follow the "Pre-Start Checklist" on the previous page. Be sure that the Wheel Gear Lever is in the ENGAGE position.
2. Put the Depth Regulator Lever in the "travel" position (lever all the way down) so that the tines are clear of the ground. Use this position when practicing with your tiller or when moving to or from the garden. When you are ready to begin tilling, you must move the Depth Regulator Lever to the desired depth setting (see "Tilling Tips & Techniques").
3. Start the engine and allow it to warm up. When warm, put Engine Throttle Control Lever in "FAST" speed setting.

**⚠ WARNING**

**Keep away from rotating tines. Rotating tines will cause injury.**

4. For *forward* motion of the wheels and tines:
  - (a) Pull one or both of the Forward Clutch Control Levers up and hold them against the handlebars. To stop forward motion of the wheels and tines, release the levers.

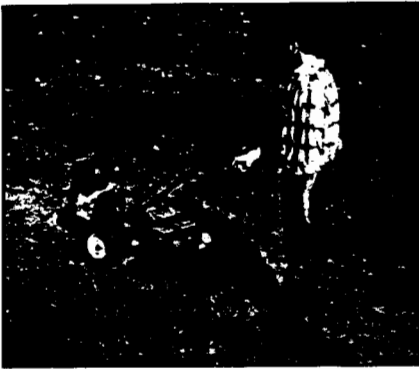

**Figure 4-2:** Use one hand to guide tiller when moving forward.

- (b) As the tiller moves forward, relax and let the wheels pull the unit along while the tines dig. Walk behind and a little to one side of the tiller. Use a light but secure grip with one hand on the handlebars, but keep your arm loose. See Figure 4-2. Let the tiller move ahead at its own pace and do not push down on the handlebars to try and force the tiller to dig deeper – this takes weight off the wheels, reduces traction, and causes the tines to try and propel the tiller.

### **⚠ WARNING**

**Do not push down on the handlebars to try to make the tiller till more deeply. This prevents the wheels from holding the tiller back and can allow the tines to rapidly propel the tiller forward, which could result in loss of control, property damage, or personal injury.**

5. For reverse motion of the wheels and tines:
- Look behind and exercise caution when operating in reverse. **Do not till while in reverse.**
  - Stop all forward motion before reversing. Lift the handlebars with one hand until the tines are off the ground and then pull the Reverse Clutch Control knob out to engage reverse motion (see Figure 4-3). To stop reverse motion, let go of the Reverse Clutch Control knob.



**Figure 4-3:** Raise tines off ground and look behind when moving in reverse.

6. To Turn the Tiller Around:
- Practice turning the tiller in a level, open area. Be very careful to keep your feet and legs away from the tines.
  - To make a turn, reduce the engine speed and then lift the handlebars until the engine and tines are balanced over the wheels (Figure 4-4).
  - With the tiller balanced, push sideways on the handlebar to move the tiller in the direction of the turn (Figure 4-5). After completing the turn, slowly lower the tines into the soil and increase the engine speed.

### **Stopping the Tiller and Engine**

- To stop the wheels and tines, release the Forward Clutch Control levers or the Reverse Clutch Control knob (whichever is engaged).
- To stop the recoil start engine, move the Engine Throttle Control Lever to "STOP". On electric start models, turn the ignition keyswitch to "OFF" to stop the engine.

### **⚠ WARNING**

Before tilling, contact your telephone or utilities company and inquire if underground equipment or lines are used in your area. Their representative will be glad to answer your questions and tell you if any of their equipment or lines are buried underground on your property.

### **Turning the Tiller Around**



**Figure 4-4:** To begin turn, reduce engine speed and lift handlebars until engine and tines are balanced over wheels.



**Figure 4-5:** With tiller balanced over wheels (and tines out of the ground), push handlebars sideways to turn tiller.

## Tilling Tips & Techniques

### Let the tiller do the work

- While tilling, relax and let the wheels pull the tiller along while the tines do the digging. Walk on the side that is not yet finished (to avoid making footprints in the freshly tilled soil) and lightly, but securely grip the handlebar with just one hand.
- Avoid pushing down on the handlebars in an attempt to force the tiller to dig deeper. Doing so takes the weight off the powered wheels, causing them to lose traction. Without the wheels helping to hold the tiller back, the tines will attempt to propel the tiller – often causing the tiller to skip rapidly across the ground. (Sometimes, slight downward pressure on the handlebars will help get through a particularly tough section of sod or unbroken ground, but in most cases this won't be necessary at all.)

### Tilling depths

- Avoid trying to dig too deeply too quickly, especially when busting sod or when tilling soil that hasn't been tilled for some time. Use shallow depth regulator settings (only an inch or two deep) for the first passes through the garden area. With each succeeding pass, adjust the depth regulator to dig another inch or two deeper. (Watering the garden area a few days prior to tilling will make tilling easier, as will letting the newly worked soil set for a day or two before making a final, deep tilling pass.)
- When cultivating (breaking up the surface soil around plants to help destroy weeds), use very shallow depth settings to prevent injury to plants whose roots often grow close to the surface. If needed, lift up on the handlebars slightly to prevent the tines from digging too deeply. (Cultivating on a regular basis not only eliminates weeds, it also loosens and aerates the soil for better moisture absorption and faster plant growth.)

### Avoid tilling soggy, wet soil

Tilling wet soil often results in large, hard clumps of soil that can interfere with planting. If time permits, wait a day or two after heavy rains to allow the soil to dry before tilling. Test soil by squeezing it into a ball. If it compresses too easily, it is too wet to till.

### Avoid making footprints

When possible, walk on the untilled side of the unit to avoid making footprints in the freshly tilled soil. Footprints cause soil compaction that can hamper root penetration and contribute to soil erosion. They can also "plant" unwanted weed seeds back into the freshly tilled ground.

### Choosing correct wheel and tine speeds

With experience, you will find the "just right" tilling depth and tilling speed combination that is best for your garden.

Set the Engine Throttle Control Lever to a speed to give the engine adequate power and yet allow it to operate at the slowest possible speed...at least until you have achieved the maximum tilling depth you desire. Faster engine speeds may be desirable when making final passes through the seedbed or when cultivating. Selection of the correct engine speed, in relation to the tilling depth, will ensure a sufficient power level to do the job without causing the engine to labor.

### Suggested tilling patterns

- When preparing a seedbed, go over the same path twice in the first row, then overlap one-half the tiller width on the rest of the passes (see Figure 4-6). When finished in one direction, make a second pass at a right angle as shown in Figure 4-7. Overlap each pass for best results (in very hard ground it may take three or four passes to thoroughly pulverize the soil).

- If the garden size will not permit lengthwise and then crosswise tilling, then overlap the first passes by one-half a tiller width, followed by successive passes at one-quarter width (see Figure 4-8).
- With planning, you can allow enough room between rows to cultivate (see Figure 4-9). Leave room for the hood width, plus enough extra room for future plant growth.

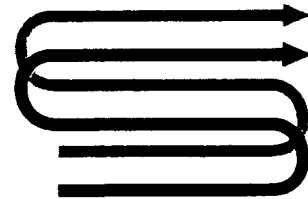

Figure 4-6

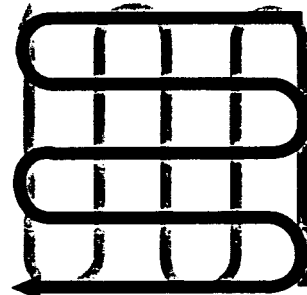

Figure 4-7

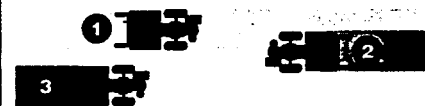

Figure 4-8

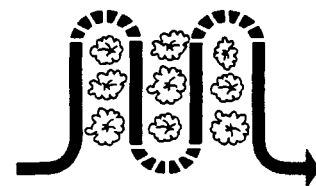

Figure 4-9

## Tilling Tips & Techniques

### Clearing the tines

The tines have a self-clearing action which eliminates most tangling of debris in the tines. However, occasionally dry grass, stringy stalks or tough vines may become tangled. Follow these procedures to help avoid tangling and to clean the tines, if necessary.

- To reduce tangling, set the depth regulator deep enough to get maximum "chopping" action as the tines chop the material against the ground. Also, try to till under crop residues or cover crops while they are green, moist and tender.
- While power composting, try swaying the handlebars from side to side (about 6" to 12"). This "fishtailing" action often clears the tines of debris.
- If tangling occurs, lift the tines out of the soil and run the tiller in reverse for a few feet. This reversing action should unwind a good deal of debris.
- If reversing the tiller doesn't clear the debris, it may be necessary to remove the debris by hand (a pocket knife will help you to cut away the material).

### WARNING

Before clearing the tines by hand, stop the engine, allow all moving parts to stop and disconnect the spark plug wire. Remove the ignition key on electric start models.

Failure to follow this warning could result in personal injury.

### Tilling on slopes

If you must garden on a moderate slope, please follow two very important guidelines:

1. Till only on moderate slopes, never on steep ground where footing is difficult (review safety rules in the "Safety" Section of this Manual).
2. We recommend tilling up and down slopes rather than terracing. Tilling vertically on a slope allows maximum planting area and also leaves room for cultivating.

**IMPORTANT:** When tilling on slopes, be sure the correct oil level is maintained in the engine (check every one-half hour of operation). The incline of the slope will cause the oil to slant away from its normal level and this can starve engine parts of required lubrication. Keep the engine oil level at the full point at all times!

#### A. Tilling up and down slopes:

- To keep soil erosion to a minimum, be sure to add enough organic matter to the soil so that it has good moisture-holding texture and try to avoid leaving footprints or wheel marks.
- When tilling vertically, try to make the first pass uphill as the tiller digs more deeply going uphill than it does downhill. In soft soil or weeds, you may have to lift the handlebars slightly while going uphill. When going downhill, overlap the first pass by about one-half the width of the tiller.

#### B. Terrace Gardening:

- When a slope is too steep or too short for vertical tilling, it may be necessary to till across the slope and create terraced rows. Terraces are rows that are cut into the side of a slope, creating a narrow, but flat area on which to plant.
- On a long slope, you can make several terraces, one below the other.

- Terraces should be only 2-to-3 feet wide. Digging too far into the side of the slope will expose poor subsoil that is unproductive for plants.
- To create a terrace, start at the top of the slope and work down. Go back and forth across the first row as shown in Figure 4-10.
- Each succeeding lower terrace is started by walking below the terrace you're preparing. For added stability of the tiller, always keep the uphill wheel in the soft, newly tilled soil. Do not till the last 12" or more of the downhill outside edge of each terrace. This untilled strip helps prevent the terraces from breaking apart and washing downhill. It also provides a walking path between rows.

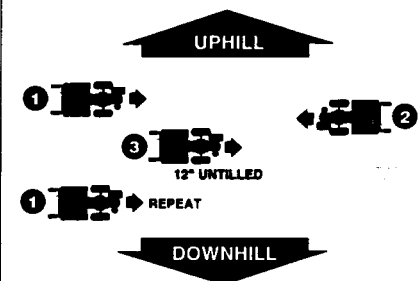

Figure 4-10

#### C. Tilling across slopes without using terraces:

- If vertical or terracing gardening aren't practical for you, then you can till laterally across a slope. We don't really recommend this method as it can create unsure footing and invites soil erosion.
- As in terrace gardening, start at the top of the slope and overlap the first pass by half the width of the tiller. For added stability of the tiller, always keep the uphill wheel in the soft, newly tilled soil.

## POWER COMPOSTING

Power composting simply means tilling under and burying in the soil all manner of organic matter such as crop residues, leaves, grass clippings and cover crops. This material will decompose during the non-growing season and add important natural nutrients to the soil.

### WARNING

When power composting, do not keep the Depth Regulator Lever at a deep setting if the tiller jumps or bucks.

If jumping or bucking occurs, move the Depth Regulator Lever down to one of the shallower settings and then slowly increase the tilling depth on later passes.

Failure to follow this warning could result in personal injury.

The first place to begin is with crop residues such as leftover vines, stalks, stems and roots. Power compost these crop residues as soon as they finish bearing. The sooner this is done, the better, as tender green matter is easier to till under. Use the deepest depth regulator setting possible without causing the engine to labor or the tiller to jump ahead.

Standing cornstalks of reasonable height can be power composted. Pushing over (but not uprooting) cornstalks will often make it easier for your tiller to chop up the stalks. Keep the tines clear of excessive tangling by "fishtailing" or frequently using reverse. Make several passes, then return a few days later to finish off any remaining stubble.

After tilling under crop residues, add more organic matter such as leaves, grass clippings and even kitchen scraps. When tilled into the soil, this organic matter will decompose and add even more important nutrients to the soil.

After power composting, you may want to plant a "green manure" cover crop to protect the soil during the off-season. You simply grow a crop of clover, alfalfa, buckwheat, peas, beans, rye grass, grain, or kale and then till it into the soil prior to the planting season.

## LOADING AND UNLOADING THE TILLER

### WARNING

Loading and unloading the tiller into a vehicle is potentially hazardous and we don't recommend doing so unless absolutely necessary, as this could result in personal injury or property damage.

However, if you must load or unload the tiller, follow the guidelines given next.

- Before loading or unloading, stop the engine, wait for all parts to stop moving, disconnect the spark plug wire and let the engine and muffler cool. Remove the ignition key on electric start models.
- The tiller is too heavy (over 170 lbs., depending on model) and bulky to lift safely by one person. Two or more people should share the load.
- Use sturdy ramps and manually (engine shut off) roll the tiller into and out of the vehicle. Two or more people are needed to do this.
- Ramps must be strong enough to support the combined weight of the tiller and any handlers. The ramps should provide good traction to prevent slipping; they should have side rails to guide the tiller along the ramps; and they should have a locking device to secure them to the vehicle.
- The handlers should wear sturdy footwear that will help to prevent slipping.
- Position the loading vehicle so that the ramp angle is as flat as possible (the less incline to the ramp, the better). Turn the vehicle's engine off and apply its parking brake.
- When going up ramps, stand in the normal operating position and push the tiller ahead of you. Have a person at each side to turn the wheels.
- When going down ramps, walk backward with the tiller following you. Keep alert for any obstacles behind you. Position a person at each wheel to control the speed of the tiller. Never go down ramps tiller-first, as the tiller could tip forward.
- Use wooden blocks to place on the downhill side of the wheels if you need to stop the tiller from rolling down the ramp. Also, use the blocks to temporarily keep the tiller in place on the ramps (if necessary), and to chock the wheels in place after the tiller is in the vehicle.
- When the tiller is in the vehicle, prevent it from rolling by engaging the wheels in the wheel drive position (put Wheel Gear Lever in ENGAGE). Chock the wheels with blocks and securely tie the tiller down.



Section  
**5**

# Maintenance

**⚠ WARNING**

Before inspecting, cleaning or servicing the machine, shut off engine, wait for all moving parts to come to a complete stop, disconnect spark plug wire and move wire away from spark plug. Remove ignition key on electric start models.

Failure to follow these instructions can result in serious personal injury or property damage.

### TILLER LUBRICATION

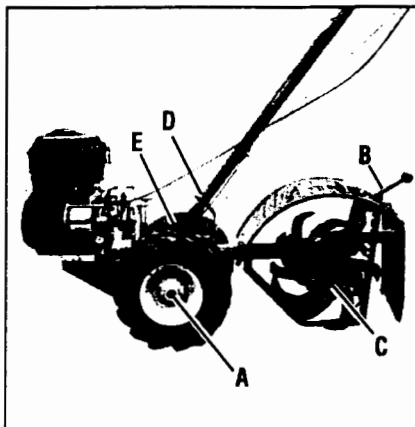

Figure 5-1: Lubrication points.

Proper lubrication of the tiller is an essential part of your maintenance program. After every 10 operating hours, oil or grease the lubrication points shown in Figure 5-1 as described below.

Use a good quality lubricating oil (#30 weight engine oil is suitable) and a good quality general purpose grease (grease that has a metal lubricant is preferred, if available).

- Remove wheels, clean wheel shaft (A, Figure 5-1) and apply thin coating of grease to shaft.
- Grease back, front and sides of depth regulator lever (B, Figure 5-1).
- Remove tines, clean tine shafts (C, Figure 5-1) and inspect for rust, rough spots or burrs (especially around holes). File or sand smooth and coat ends of shaft with grease.
- Oil the threads on the handlebar height adjustment screw (D, Figure 5-1).
- Oil the threads on the handlebar attaching screws (E, Figure 5-1).

### CHECK HARDWARE

At least every 10 operating hours, check the unit for loose or missing hardware (screws, bolts, nuts, hairpin cotters, etc.). Loose or missing hardware can lead to equipment failure, poor performance or oil leaks.

Be sure to check the three end cap mounting screws located at the rear of the transmission (Figure 5-2). Lift the tine flap to service those screws.



Figure 5-2

### CHECK TIRE PRESSURE

Check the air pressure in both tires. Deflate or inflate both tires evenly to 15-to-20 PSI (pounds per square inch). Be sure that both tires have the same air pressure or the unit will tend to pull to one side.

### MAINTENANCE SCHEDULE

PROCEDURE	NOTES
Check motor oil level	2, 3
Clean engine	2, 7
Check drive belt tension	1, 4
Check nuts and bolts	1, 4
Change motor oil	1, 4, 6
Lubricate tiller	4
Service foam pre-cleaner air filter (if so equipped)	7
Service paper air filter (if so equipped)	7
Check gear oil level in transmission	1, 5
Check tines for wear	5
Check air pressure in tires	5
Service spark plug	7

**NOTES**

- 1 - After first 2 hours of break-in operation.
- 2 - Before each use.
- 3 - Every 5 operating hours.
- 4 - Every 10 operating hours.
- 5 - Every 30 operating hours.
- 6 - More frequently in dusty or dirty conditions.
- 7 - See Engine Owner's Manual for service recommendations.
- 8 - Whichever time interval occurs first.

**WARNING**

Before inspecting, cleaning or servicing the machine, shut off engine, wait for all moving parts to come to a complete stop, disconnect spark plug wire and move wire away from spark plug. Remove the key from the keyswitch on units so equipped.

Failure to follow these instructions can result in serious personal injury or property damage.

### CHECK FOR OIL LEAKS

Before each use, check your tiller for signs of an oil leak – usually a dirty, oily accumulation either on the unit or on the floor where it has been parked.

A little seepage around a cover or oil seal is usually not a cause for alarm. However, if the oil drips overnight then immediate attention is needed as ignoring a leak can result in severe transmission damage.

If a cover is leaking, try tightening any loose screws or bolts. If the fasteners are tight, a new gasket or oil seal may be required. If the leak is from around a shaft and oil seal, the oil seal probably needs to be replaced. See your authorized dealer or contact the factory for service or advice.

**IMPORTANT:** Never operate the tiller if the transmission is low on oil. Check the oil level after every 30 hours of operation and whenever there is any oil leakage.

### TRANSMISSION GEAR OIL SERVICE

Check the transmission gear oil level after every 30 hours of operation or whenever you notice any oil leak. Operating the tiller when the transmission is low on oil can result in severe damage.

#### A. To Check Transmission Gear Oil Level:

1. Check the gear oil level when the transmission is cool. Gear oil will expand in warm operating temperatures and this expansion will provide an incorrect oil level reading.

2. To check the gear oil level (and to add oil, if necessary), refer to "STEP 5: Check Gear Oil Level in Transmission" in Section 2 of this manual.

#### B. To Drain and Refill the Transmission:

The transmission gear oil does not need to be changed unless it has been contaminated with dirt, sand or metal particles.

1. Prop up the left side of the unit so that it will be securely supported when the left side wheel is removed. Remove the left side wheel by removing the wheel mounting hardware.

2. Unscrew the plastic gear oil fill plug from the top of the transmission.

3. Place a clean pan below the transmission drain plug (see Figure 5-3) and remove the drain plug. The oil will start flowing out of the drain hole (it may flow slowly, especially in cold temperatures).

4. Remove the transmission gear oil level check plug that is located a few inches above the left side wheel shaft.

5. When the oil stops flowing, tilt the transmission forward to drain oil from the rear of the transmission.

6. After draining the oil, clean the threads of the drain plug, apply a non-hardening removable gasket sealant to the threads, and securely reinstall the drain plug.

7. Using a clean funnel, slowly add SAE 140 or SAE 85W-140 weight gear oil (with an API rating of GL-4 only) to the transmission. The transmission holds approximately 3-1/4 pints (52-54 ounces). Tilt the tiller slightly backwards to make sure the gear oil reaches the rear (tine) end of the transmission. Stop adding gear oil when it begins to flow from the oil level check hole on the side of the transmission.

8. Securely reinstall the oil level check plug.

9. Securely reinstall the gear oil fill plug on top of the transmission.

10. Reinstall the wheel and remove the prop.

**WARNING**

Before inspecting, cleaning or servicing the machine, shut off engine, wait for all moving parts to come to a complete stop, disconnect spark plug wire and move wire away from spark plug. Remove the key from the keyswitch on units so equipped.

Failure to follow these instructions can result in serious personal injury or property damage.

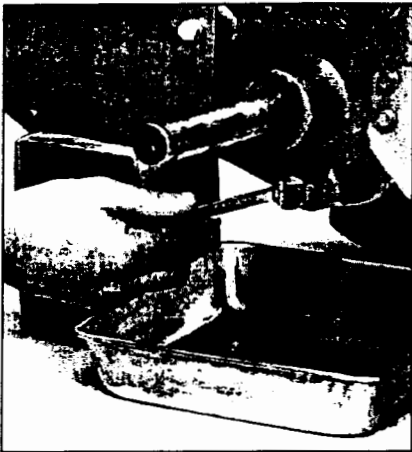

*Figure 5-3: Remove drain plug to drain transmission gear oil (also remove oil fill plug and oil level check plug).*

### ENGINE OIL SERVICE

Check the engine oil level before starting the engine each day and check it after each 5 hours of continuous operation. Running the engine when it is low on oil will quickly ruin the engine.

It is recommended that you change the motor oil after every 10 hours of operation and even sooner when operating in extremely dirty or dusty conditions. Refer to the separate Engine Owner's Manual for detailed service instructions.

#### A. To Check the Engine Oil Level:

1. Move the tiller to a level area and shut off the engine.
2. Level the engine by moving the Depth Regulator Lever up or down as needed.
3. Clean the area around the oil dipstick or oil fill tube to prevent dirt from falling into the crankcase.
4. On engines with an oil fill tube, remove the filler cap, add oil (if required) until it reaches the top of the tube and reinstall the filler cap.

5. On engines with a dipstick, remove it, wipe it clean, and reinstall it finger-tight. Remove the dipstick and check the reading. Add oil (if required) to bring the level to the FULL mark. Do not overfill.

#### B. To Change the Engine Oil:

Change the engine oil as instructed in the separate Engine Owner's Manual.

### AIR CLEANER SERVICE

The engine air cleaner filters dirt and dust out of the air before it enters the carburetor. Operating the engine with a dirty, clogged air filter can cause poor performance and damage to the engine. Never operate the engine without the air cleaner installed. Inspect and service the air cleaner more often if operating in very dusty or dirty conditions.

Service the air cleaner as instructed in the separate Engine Owner's Manual.

### SPARK PLUG SERVICE

Inspect and clean or replace the spark plug after every 100 operating hours or annually. Clean the plug and set the gap as described in the separate Engine Owner's Manual.

In some areas, local law requires using resistor spark plugs to suppress ignition signals. If the engine was originally equipped with a resistor spark plug, use the same type for replacement.

### SPARK ARRESTER SCREEN SERVICE

If the engine muffler is equipped with a spark arrester screen, remove and clean it according to the time intervals and instructions in the separate Engine Owner's Manual.

### ENGINE CLEANING

The engine must be kept clean to assure smooth operation and to prevent damage from overheating. Refer to the separate Engine Owner's Manual for specific repair and cleaning instructions. All inspections and services must be done with the engine shut off and cool to the touch.

### CARBURETOR/GOVERNOR CONTROL ADJUSTMENTS

#### WARNING

Operators shall not tamper with the engine governor settings on the machine; the governor controls the maximum safe operating speed to protect the engine and all moving parts from damage caused by overspeed. Authorized service shall be sought if a problem exists.

The carburetor was adjusted at the factory for best operating speed. Refer to the separate Engine Owner's Manual for any adjustment information or see your authorized engine service dealer.

The governor controls the maximum safe operating speed and protects the engine and all moving parts from damage caused by overspeeding. Do not tamper with the engine governor settings. Seek authorized service if a problem exists.

### THROTTLE CONTROL ADJUSTMENT

If the engine does not respond to various throttle lever settings, refer to the separate Engine Owner's Manual for service information or contact your local authorized engine service dealer.

**WARNING**

Before inspecting, cleaning or servicing the machine, shut off engine, wait for all moving parts to come to a complete stop, disconnect spark plug wire and move wire away from spark plug. Remove the key from the keyswitch on units so equipped.

Failure to follow these instructions can result in serious personal injury or property damage.

**WHEEL GEAR CABLE ADJUSTMENT**

When the Wheel Gear Lever is in DISENGAGE, the wheels will roll freely (free-wheel). The wheels should not roll freely when the lever is in ENGAGE. If the wheels roll freely when the Wheel Gear Lever is in ENGAGE, the wheel gear cable needs to be adjusted as described below.

1. With the engine shut off and the spark plug wire disconnected, put the Wheel Gear Lever in ENGAGE.
2. Loosen the top adjustment nut (A, Figure 5-4) on the wheel gear cable bracket that is located on the left side rear of the transmission.
3. Push the wheel gear cable (B) down and roll the tiller slightly forward or backward until the eccentric lever (C) engages (locks) the wheels. Hold the cable in that position and tighten the top (A) and bottom (D) adjustment nuts.
4. Move the Wheel Gear Lever to ENGAGE and DISENGAGE several times to check the adjustment. The wheels should not roll when the lever is in ENGAGE, but they should roll when the lever is in DISENGAGE. Readjust the cable as required.

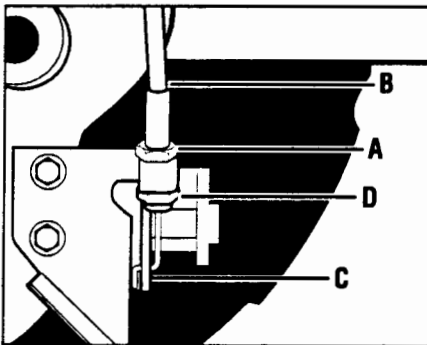

Figure 5-4: Wheel gear cable assembly.

**OFF SEASON STORAGE**

When the tiller won't be used for extended periods, prepare it for storage as follows:

1. Clean the tiller and engine.
2. Do routine tiller lubrication and check for loose parts and hardware.
3. Protect the engine and perform recommended engine maintenance by following the engine storage instructions found in the separate Engine Owner's Manual.  
NOTE: Be sure to protect the fuel lines, carburetor and fuel tank from gum deposits by removing fuel or by treating fuel with a fuel stabilizer (follow engine manufacturer's recommendations).
4. On electric start units, follow "Battery Storage" instructions in this Section.
5. Store unit in a clean, dry area.
6. Never store the tiller with fuel in the fuel tank in an enclosed area where gas fumes could reach an open flame or spark, or where ignition sources are present (space heaters, hot water heaters, furnaces, etc.).

**BOLO TINES**

The tines will wear with use and should be inspected at the beginning of each tilling season and after every 30 operating hours. Tines can be replaced individually or as a complete set. Never inspect or service the tines unless the engine is stopped, the spark plug wire is disconnected, and the ignition key is removed on electric start models.

**A. Tine Inspection:**

With use, the tines will become shorter, narrower and pointed (Figure 5-5). Badly worn tines will result in a loss of tilling depth and reduced effectiveness when chopping up and turning under organic matter. Use Figure 5-5 as a guide to when the tines should be replaced.

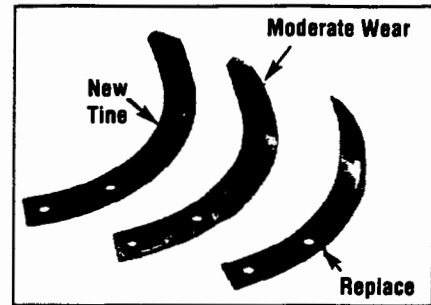

Figure 5-5: Checking tines for wear.

**B. Removing a Single Tine:**

1. Remove the two screws and nuts that attach a single tine to the tine holder (Figure 5-6). If needed, use penetrating oil to help free the nuts.
2. When installing a single tine, be sure to position it so that its *cutting edge will enter the soil first as the tiller moves forward*.

**C. Removing a Tine Assembly:**

1. If removing both tine assemblies, mark them "left" and "right" before removal. Doing so will help ensure that the assemblies are reinstalled on the correct sides of the tiller.
2. Remove the screw and locknut that secure the tine assembly to the tine shaft (Photo 5-7). Pull the tine assembly off the shaft (if necessary, use a rubber mallet to tap the tine assembly outward).
3. Before reinstalling the tine assembly, inspect the tine shaft for rust, rough spots or burrs and file or sand as needed. Apply a thin coat of grease to the shaft.
4. Install each tine assembly so that *the cutting edge of the tines will enter the soil first when the tiller moves forward*. Secure the tine assembly to the tine shaft using the screw and locknut previously removed. Tighten securely.

**⚠ WARNING** Before inspecting, cleaning or servicing the machine, shut off engine, wait for all moving parts to come to a complete stop, disconnect spark plug wire and move wire away from spark plug. Remove the key from the keyswitch on units so equipped. Failure to follow these instructions can result in serious personal injury or property damage.

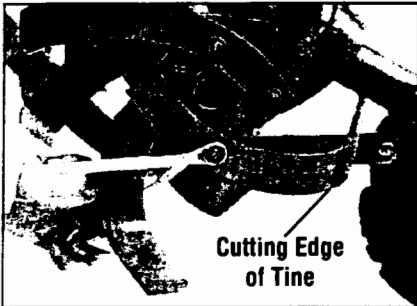

Figure 5-6: Removing single tine.

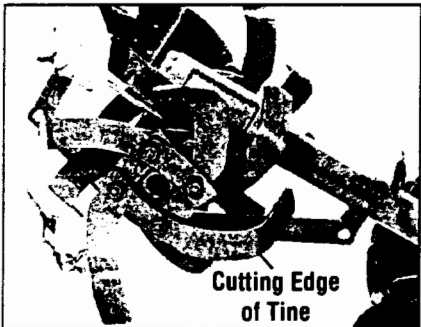

Figure 5-7: Removing a tine assembly.

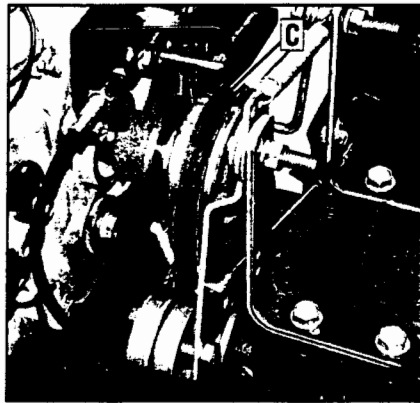

Figure 5-8: Forward clutch belt. (C, Left-side view, no belt cover.)

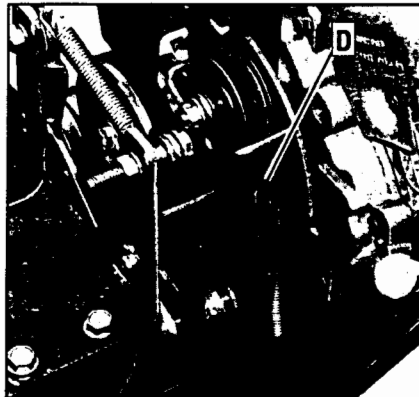

Figure 5-9: Reverse clutch belt (D). (Right-side view, no belt cover.)

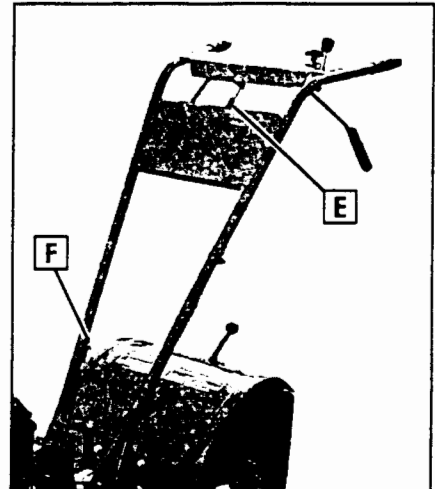

Figure 5-10: Location of forward clutch cable spring (E) and forward cable adjuster (F).

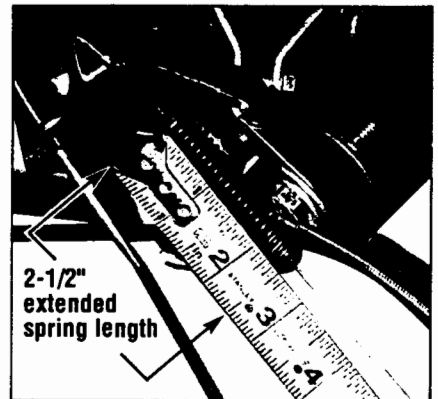

Figure 5-11: Correct spring length when Forward Clutch Levers are engaged is 2-1/2".

**⚠ WARNING** Follow the belt adjustment instructions carefully. An incorrect adjustment could result in the clutch control mechanism engaging too soon. This could cause loss of tiller control and result in personal injury or property damage.

**CHECKING AND ADJUSTING TENSION ON CLUTCH BELTS**

Maintaining correct belt tension is important to good tilling performance and long belt life. A loose belt will slip on the engine and transmission pulleys and cause the tines and wheels to slow down – or stop – even though the engine is running at full speed. A loose belt will also result in premature belt wear.

While checking belt tension, also check for cracks, cuts or frayed edges. A belt in poor condition should be replaced.

Tension on a new forward clutch belt (C, Figure 5-8) should be checked after the

first two (2) hours of operation and after every ten (10) hours of operation.

The reverse clutch belt (D, Figure 5-9), because it is used more sparingly, may not require tension adjustment until a significant number of operating hours has passed. A tension adjustment is required only if there is little or no reverse movement when the Reverse Clutch Control knob is pulled out.

**Checking and Adjusting Forward Clutch Belt Tension**

It is important to maintain correct tension on the forward clutch belt. A loose belt will cause the tines and wheels to slow down – or stop completely – even though the engine is running at full speed.

A loose belt will also result in premature belt wear.

- Check belt tension after the first two hours of break-in operation and after every 10 operating hours.
- At the end of each tilling season, check the belt for cracks, cuts or frayed edges. A belt in poor condition should be replaced.

**WARNING**

Before inspecting, cleaning or servicing the machine, shut off engine, wait for all moving parts to come to a complete stop, disconnect spark plug wire and move wire away from spark plug. Remove the key from the keyswitch on units so equipped.

Failure to follow these instructions can result in serious personal injury or property damage.

**CAUTION**

Incorrect cable adjustment could cause the wheels and tines to rotate unexpectedly. Follow adjustment procedures carefully. Failure to do so could result in personal injury or property damage.

**Checking Forward Belt Tension**

1. Before checking, shut off engine, allow the engine and muffler to cool down, disconnect the spark plug wire, remove the ignition key on electric start models.
2. The coiled part of the forward clutch spring (E, Figure 5-10) measures 2" in length when the Forward Clutch Control levers are not pulled up. Pull either Forward Clutch Control Lever up against the handlebar and measure the length of the coil on the forward clutch spring. Tension is correct if the length of the extended coil is 2-1/2" (see Figure 5-11). The forward clutch control cable needs adjustment if the extended length of the coil is not 2-1/2". See *Adjusting the Forward Clutch Belt* for a procedure.

**Adjusting the Forward Clutch Cable**

Do this procedure if the forward clutch spring measurement is not correct (see *Checking Forward Belt Tension*).

1. Before adjusting the belt, shut off engine, allow the engine and muffler to cool down, disconnect the spark plug wire, and remove the ignition key on electric start models.

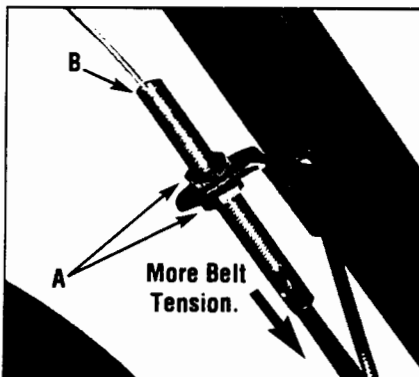

Figure 5-12: Move forward clutch cable adjuster down for more belt tension.

2. Belt adjustments are done with the

forward clutch cable adjuster (F, Figure 5-10). Use two 1/2", open-end wrenches to loosen the two jam nuts (A, Figure 5-12) a few turns.

3. Move cable adjuster (B, Figure 5-12) downward for more belt tension (see Figure 5-12).
4. Hand tighten the jam nuts and pull the Forward Clutch Control levers up against the handlebar. Measure the spring coil (Figure 5-11). The extended length of the coil should be 2-1/2". Repeat this procedure until the extended spring length is correct.
5. Tighten both jam nuts securely.

**Checking and Adjusting Reverse Clutch Belt Tension****Checking Reverse Clutch Belt Tension**

The reverse clutch belt (D, Figure 5-9) needs adjustment if the belt slips in reverse or if there is no reverse. See *Adjusting Reverse Clutch Belt* below.

**Adjusting Reverse Clutch Belt**

1. Before adjusting the belt, shut off engine, allow the engine and muffler to cool down, disconnect the spark plug wire, and remove the ignition key on electric start models.

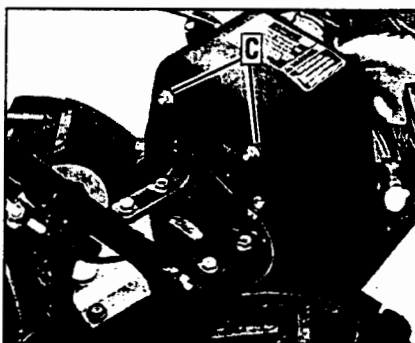

Figure 5-13: Belt cover.

2. Remove the two nuts (C, Figure 5-13) and remove the belt cover.
3. Reverse belt tension adjustments are done with the reverse clutch cable adjuster located on the left side of the machine near the engine (D, Figure 5-14). Use two 1/2" open-end wrenches to loosen the two adjuster jam nuts (E) a few turns.

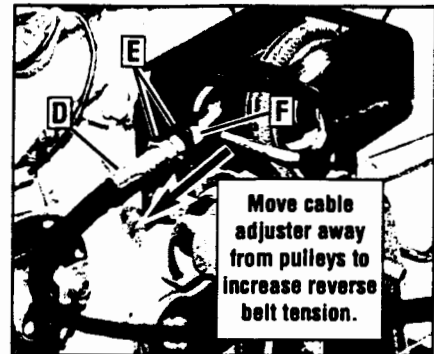

Figure 5-14: Reverse clutch cable adjuster. Left-side view with belt cover removed.

4. Move the cable adjuster (D, Figure 5-14) away from the pulleys to increase belt tension.
5. Tighten both jam nuts securely.
6. Reinstall the belt cover.
7. Move the unit to an open area and test the reverse operation. Repeat this procedure if the unit does not respond when the reverse clutch is engaged.

**FORWARD CLUTCH BELT REMOVAL AND REPLACEMENT**

The forward clutch belt (K, Figure 5-15) engages the engine pulley (I) and the transmission pulley (J) when either Forward Clutch Control Lever is pulled up against the handlebar. This tightens the forward clutch cable (G) which causes the forward clutch idler pulley (H) to apply pressure to the forward clutch belt. This causes the pulleys to turn for Forward movement.

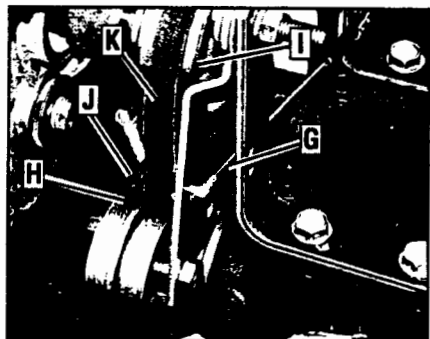

Figure 5-15: Forward clutch control assembly.

**WARNING**



Before inspecting, cleaning or servicing the machine, shut off engine, wait for all moving parts to come to a complete stop, disconnect spark plug wire and move wire away from spark plug. Remove the key from the keyswitch on units so equipped. Failure to follow these instructions can result in serious personal injury or property damage.

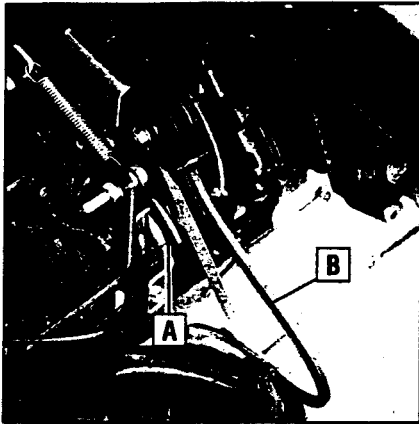

Figure 5-16

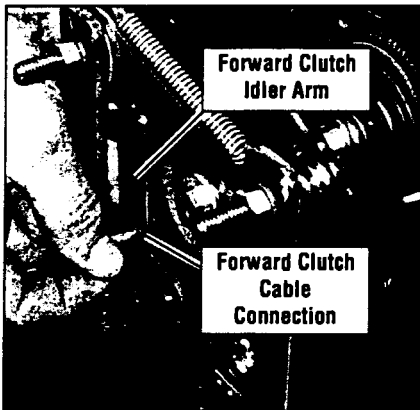

Figure 5-17

**Removing Forward Clutch Belt**

1. Stop engine, allow it to cool and disconnect spark plug wire before working near belts. Also remove ignition key on electric start models.
2. Remove the two nuts (C, Figure 5-13) and remove the belt cover.
3. Move the reverse clutch belt (B, Figure 5-16) out of the way. You do not need to completely remove the belt. Press the reverse idler pulley inward for slack and then slip the bottom half of the belt completely off the transmission pulley (A, Figure 5-16). Pull the bottom half of the belt out of the housing and let it hang off the outside of the unit (B).
4. Disconnect the forward clutch cable from the forward clutch idler arm bracket

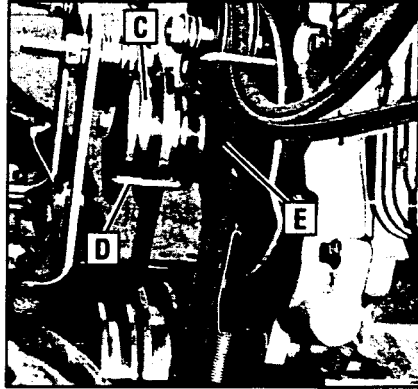

Figure 5-18

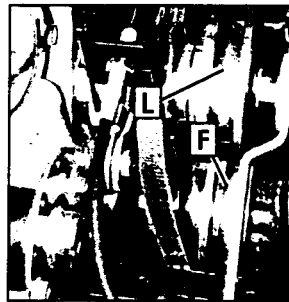

Figure 5-19: Left-side view.

(Figure 5-17). Note the hole from which you disconnect the cable. It is important that you reconnect the cable to the same hole.

5. Slide the belt off the engine pulley (C, Figure 5-18), away from engine, out from under the belt guide (D), and completely off the pulley.
6. Slip the belt off the front of the transmission pulley (F, Figure 5-19).
7. Work the belt out from between the pulley and the frame, around the transmission cover spring, then up and out of the machine.

**Installing Forward Clutch Belt**

1. Stop engine, allow it to cool and disconnect spark plug wire before working near belts. Also remove ignition key on electric start models.
2. Remove the old forward clutch belt as described in *Removing Forward Clutch Belt*.

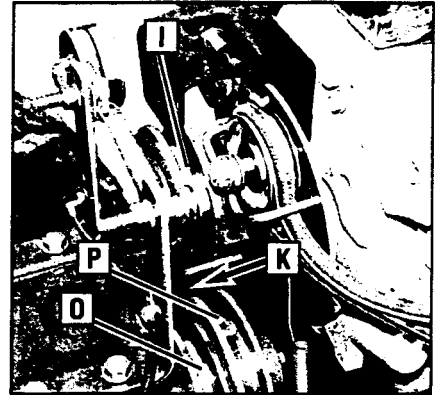

Figure 5-20: Arrow (K) shows insertion point for installing new forward clutch belt.

3. From the front of tiller, insert the forward clutch belt in between the bottom of the engine drive pulley (I) and the top of transmission pulley (K, Figure 5-20).
4. Insert the bottom half of belt into the smaller, rear-most groove of the transmission pulley (F, Figure 5-19). Now slip the top half of belt under the belt guide (D, Figure 5-18) and onto the large groove of engine drive pulley (L, Figure 5-19).

5. Reconnect the forward clutch cable to the correct hole in the idler arm bracket, as shown in Figure 5-17.

NOTE: Be sure to run the reverse clutch cable on the pulley side of the cover support brackets (G, Figure 5-21).



Figure 5-21: Correct forward clutch cable positioning.

**IMPORTANT:** Belt must be installed on the inside of the belt guide (H, Figure 5-21).

6. Reinstall the reverse clutch belt. Insert the bottom of the belt into the frame, then



**WARNING**

Before inspecting, cleaning or servicing the machine, shut off engine, wait for all moving parts to come to a complete stop, disconnect spark plug wire and move wire away from spark plug. Remove the key from the keyswitch on units so equipped.

Failure to follow these instructions can result in serious personal injury or property damage.

pull down on the belt and roll it onto the large, forward-most groove of the transmission pulley (P, Figure 5-20).

7. Reinstall the belt cover.

8. Test for correct tension on the forward clutch belt (see *Checking Forward Belt Tension*).

### REVERSE CLUTCH BELT REMOVAL AND REPLACEMENT

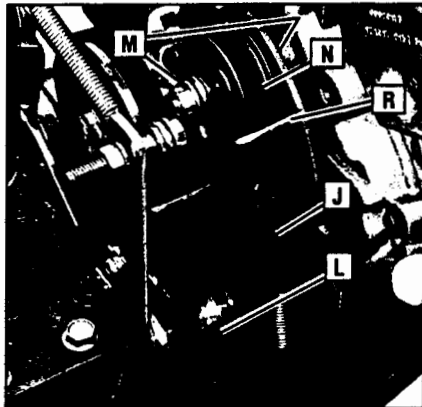

Figure 5-22: Right-side view.

The reverse clutch belt (J, Figure 5-22) is driven by the engine drive pulley (I, Figure 5-20). When the Reverse Clutch Control knob is pulled out, it pulls the reverse idler arm and pulley (N) which tightens the belt against the engine drive pulley. This drives the transmission drive pulley (L), resulting in reverse motion.

#### Removing Reverse Clutch Belt

1. Stop engine, allow it to cool and disconnect spark plug wire before working near belts. Also remove ignition key on electric start models.
2. Remove belt cover (Figure 5-13) by removing two flange locknuts.
3. Pull the reverse clutch belt downward and slip it off the transmission pulley (L, Figure 5-22).

4. Use two 1/2" wrenches to loosen and remove wire belt guide (R, Figure 5-22) from the reverse idler arm pulley. Do not remove locknut and screw.

5. Remove the reverse belt and pull it out through front of transmission housing.

#### Installing Reverse Clutch Belt

1. Stop engine, allow it to cool and disconnect spark plug wire before working near belts. Also remove ignition key on electric start models.

**IMPORTANT:** The forward clutch belt must be installed before the reverse clutch belt.

2. Install the forward clutch belt (see *Installing Forward Clutch Belt* in this section) before installing reverse belt.

**IMPORTANT:** The reverse belt has a "V" shape. When installing the belt, make sure that the widest (flat) side of the belt rides against the reverse idler pulley (N, Figure 5-22) and transmission pulley (L). If needed, the belt can be twisted "inside out" so that the "V" shaped side is on the outside and the widest side is on the inside.

3. Insert the belt down into the front of the transmission housing. Slip the top half of the belt onto the reverse idler arm pulley (N).

4. Pull the belt downward and loop the bottom half of belt around the front groove of transmission pulley (L, Figure 5-22).

5. Mount the belt guide between the two flat washers and tighten snugly. The guide needs adjusting before fully tightening.

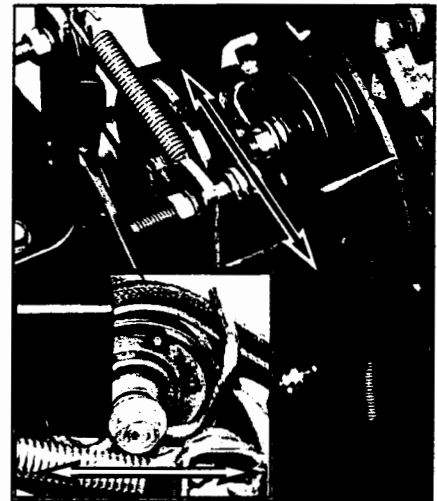

Figure 5-23: Reverse belt guide positioning.

6. (You will need an assistant to help with this step.) Pull the reverse idler pulley (N) up to its highest point and position the belt guide (R) horizontally level as shown in Figure 5-23. Securely tighten the screw and lock nut (M, Figure 5-22).

7. Pull back on the Reverse Clutch Control knob and make sure that the reverse clutch belt fully contacts the groove in the engine pulley. Release knob and make sure that the belt doesn't engage the reverse engine pulley. This may cause the unit to move in reverse when the Wheel Gear Lever is engaged. Adjust the cable for less tension if this condition occurs. See *Checking and Adjusting Reverse Belt Tension* for more information.

8. Reinstall the belt cover and secure it with two flange locknuts.

9. Test the unit in an open location.



**TROUBLESHOOTING**

<b>PROBLEM</b>	<b>POSSIBLE CAUSE</b>	<b>CORRECTION</b>
<b>Engine does not start.</b>	<ol style="list-style-type: none"> <li>1. Spark plug wire disconnected.</li> <li>2. Engine Throttle Control Lever incorrectly set.</li> <li>3. Fuel tank empty.</li> <li>4. Choke control (if so equipped) in incorrect position.</li> <li>5. Stale gasoline.</li> <li>6. Dirty air filter(s).</li> <li>7. Defective or incorrectly gapped spark plug.</li> <li>8. Carburetor out of adjustment.</li> <li>9. Misadjusted throttle control.</li> <li>10. Dirt or water in fuel tank.</li> </ol>	<ol style="list-style-type: none"> <li>1. Reconnect wire.</li> <li>2. Put lever in FAST position.</li> <li>3. Add fuel.</li> <li>4. See Engine Owner's Manual.</li> <li>5. Drain fuel and add fresh fuel.</li> <li>6. Clean or replace filter(s).</li> <li>7. Inspect spark plug.</li> <li>8. See Engine Service Dealer.</li> <li>9. See Engine Service Dealer.</li> <li>10. See Engine Service Dealer.</li> </ol>
<b>Engine runs poorly.</b>	<ol style="list-style-type: none"> <li>1. Defective or incorrectly gapped spark plug.</li> <li>2. Dirty air filter(s).</li> <li>3. Carburetor out of adjustment.</li> <li>4. Stale gasoline.</li> <li>5. Dirt or water in fuel tank.</li> <li>6. Engine cooling system clogged.</li> </ol>	<ol style="list-style-type: none"> <li>1. Inspect spark plug (see Engine Owner's Manual).</li> <li>2. Clean or replace (see Engine Owner's Manual).</li> <li>3. See Engine Service Dealer.</li> <li>4. Replace with fresh gasoline.</li> <li>5. See Engine Service Dealer.</li> <li>6. Clean air cooling system (see Engine Owner's Manual).</li> </ol>
<b>Engine overheats.</b>	<ol style="list-style-type: none"> <li>1. Engine cooling system clogged.</li> <li>2. Carburetor out of adjustment.</li> <li>3. Oil level is low.</li> </ol>	<ol style="list-style-type: none"> <li>1. Clean air cooling area (see Engine Owner's Manual).</li> <li>2. See Engine Service Dealer.</li> <li>3. Check oil level (see Engine Owner's Manual).</li> </ol>
<b>Engine does not shut off.</b>	<ol style="list-style-type: none"> <li>1. Misadjusted throttle control cable (recoil start model).</li> </ol>	<ol style="list-style-type: none"> <li>1. See Engine Owner's Manual or Engine Service Dealer.</li> </ol>
<b>Wheels and Tines will not turn.</b>	<ol style="list-style-type: none"> <li>1. Improper use of controls.</li> <li>2. Forward Clutch: Misadjusted forward clutch control cable.</li> <li>3. Reverse Clutch: Misadjusted clutch control cable.</li> <li>4. Worn or broken clutch belt(s).</li> <li>5. Internal transmission wear or damage.</li> <li>6. Bolt and key loose in transmission pulley.</li> </ol>	<ol style="list-style-type: none"> <li>1. Review Sections 3 and 4.</li> <li>2. Adjust cable tension (Section 5).</li> <li>3. Adjust cable tension (Section 5).</li> <li>4. Check belts. Replace parts as needed (Section 5).</li> <li>5. Contact local dealer or the factory.</li> <li>6. Tighten bolt; check that key is in place.</li> </ol>
<b>Tines turn, but wheels don't.</b>	<ol style="list-style-type: none"> <li>1. Wheel mounting hardware missing.</li> <li>2. Bolt and key loose in transmission pulley.</li> <li>3. Internal transmission wear or damage.</li> <li>4. Misadjusted wheel gear cable.</li> <li>5. Wheel Gear Lever not fully engaged.</li> </ol>	<ol style="list-style-type: none"> <li>1. Replace hardware.</li> <li>2. Tighten bolt; check that key is in place.</li> <li>3. Contact local Dealer or the Factory.</li> <li>4. See "Wheel Gear Cable Adjustment," Section 5.</li> <li>5. Engage lever (see Section 3).</li> </ol>
<b>Wheels Turn, but Tines Don't.</b>	<ol style="list-style-type: none"> <li>1. Tine holder mounting hardware missing.</li> <li>2. Internal transmission wear or damage.</li> </ol>	<ol style="list-style-type: none"> <li>1. Replace hardware.</li> <li>2. Contact local Dealer or the Factory.</li> </ol>
<b>Poor tilling performance.</b>	<ol style="list-style-type: none"> <li>1. Worn tines.</li> <li>2. Improper Depth Regulator setting.</li> <li>3. Incorrect throttle setting.</li> <li>4. Belt(s) slipping.</li> </ol>	<ol style="list-style-type: none"> <li>1. See "Bolo Tines" (Section 5).</li> <li>2. See "Tilling Tips &amp; Techniques," Section 4.</li> <li>3. See Section 4.</li> <li>4. See "Checking Clutch Belt Tension," Section 5.</li> </ol>

**TILLER ATTACHMENTS**

The attachments listed below are available for your tiller. Contact your authorized dealer or the factory for current information.

**BUMPER — MODEL OEM-290-254**

The tubular steel bumper helps to protect the engine from damage.

**HILLER/FURROWER — MODEL OEM-290-251**

The furrower blade attaches to the back of the depth regulator assembly and is used to create rows, trenches and ditches up to 8" deep, depending on soil conditions. The two hiller wings attach to the sides of the furrower blade and are used to make hilled rows and raised bed gardens.

**ROW MARKER — MODEL OEM-290-257**

The row marker attaches to the hiller/furrower attachment and is used to scratch lines in the seedbed for laying out furrows, trenches, raised beds, etc. (eliminates the need for stakes, string and measuring tape). The row marker is adjustable in length from 28" to 49-3/4", allowing you to vary the width of the marked rows as required.